

RUOTE E SUPPORTI  
RUOTE MOBILIO  
RUOTE PNEUMATICHE



**RUOTE IN GOMMA STANDARD / STANDARD RUBBER WHEELS**  
**RUEDAS DE GOMA ESTÁNDAR / ROULETTES EN CAOUTCHOUC PLEIN STANDARD**

<b>RNT</b>	RUOTE IN GOMMA NERA/GRIGIA CON NUCLEO IN POLIPROPILENE BLACK/GREY RUBBER WHEELS WITH POLYPROPYLENE CENTRE RUEDAS DE GOMA NEGRA/GRIS CON NÚCLEO DE POLIPROPILENO ROULETTES EN CAOUTCHOUC PLEIN NOIR/GRIS ET CORPS EN POLYPROPYLENE	page 3
<b>RNM</b>	RUOTE IN GOMMA NERA CON NUCLEO IN LAMIERA ZINCATA BLACK RUBBER WHEELS WITH STEEL CENTRE RUEDAS DE GOMA NEGRA CON NÚCLEO DE ACERO ROULETTES EN CAOUTCHOUC PLEIN NOIR ET JANTES EN ACIER	page 4

**RUOTE IN GOMMA ELASTICA / ELASTIC RUBBER WHEELS**  
**RUEDAS DE GOMA ELÁSTICA / ROULETTES EN CAOUTCHOUC ELASTIQUE**

<b>REB</b>	RUOTE ELASTICHE BLU/GRIGIE CON NUCLEO IN POLIAMMIDE BLUE/GREY ELASTIC RUBBER WHEELS WITH POLYAMIDE CENTRE RUEDAS DE GOMA ELÁSTICA AZUL/GRIS CON NÚCLEO DE POLIAMIDA ROULETTES EN CAOUTCHOUC ELASTIQUE BLEU/GRIS ET CORPS EN POLYAMIDE	page 5
<b>RA</b>	RUOTE ELASTICHE NERE CON NUCLEO IN ALLUMINIO BLACK ELASTIC RUBBER WHEELS WITH ALUMINIUM CENTRE RUEDAS DE GOMA ELÁSTICA NEGRA CON NÚCLEO DE ALUMINIO ROULETTES EN CAOUTCHOUC ELASTIQUE NOIR ET CORPS EN ALUMINIUM	page 6
<b>RC</b>	RUOTE ELASTICHE NERE CON NUCLEO IN GHISA BLACK ELASTIC RUBBER WHEELS WITH CAST IRON CENTRE RUEDAS DE GOMA ELÁSTICA NEGRA CON NÚCLEO DE HIERRO FUNDIDO ROULETTES EN CAOUTCHOUC ELASTIQUE NOIR ET CORPS EN FONTE	page 7

**RUOTE POLIPROPILENE E NYLON / POLYPROPYLENE AND POLYAMIDE WHEELS**  
**RUEDAS DE POLIPROPILENO Y POLIAMIDA / ROUES AVEC POLYPROPYLENE ET POLYAMIDE**

<b>PPP</b>	RUOTE A STRUTTURA MONOLITICA IN POLIPROPILENE POLYPROPYLENE MONOLITHIC WHEELS RUEDAS MONO-BLOQUE DE POLIPROPILENO ROUES MONOLITHIQUES EN POLYPROPYLENE	page 8
<b>NYPUR</b>	RUOTE CON NUCLEO IN POLIAMMIDE E RIVESTIMENTO IN POLIURETANO WHEELS WITH POLYAMIDE CENTRE AND POLYURETHANE TREAD RUEDAS CON NUCLEO DE POLIAMIDA Y BANDA DE POLIURETANO ROUES AVEC CENTRE EN POLYAMIDE ET BANDAGE EN POLYURETHANE	page 9

**RUOTE IN POLIURETANO / POLYURETHANE WHEELS**  
**RUEDAS DE POLIURETANO/ ROULETTES EN POLYURETHANE**

<b>PA</b>	RUOTE CON NUCLEO IN ALLUMINIO E RIVESTIMENTO IN POLIURETANO WHEELS WITH ALUMINIUM CENTRE AND POLYURETHANE TREAD RUEDAS DE POLIURETANO CON NÚCLEO DE ALUMINIO ROULETTES AVEC CORPS EN ALUMINIUM ET BANDAGE EN POLYURETHANE	page 10
<b>PC</b>	RUOTE IN GHISA CON RIVESTIMENTO IN POLIURETANO CAST IRON WHEELS WITH POLYURETHANE TREAD RUEDAS DE POLIURETANO CON NÚCLEO DE HIERRO FUNDIDO ROULETTES EN FONTE ET BANDAGE EN POLYURETHANE	page 11
<b>C</b>	RUOTE MONOLITICHE IN GHISA CAST IRON WHEELS AROS EN HIERRO FUNDIDO ROUES EN FONTE	page 12
<b>PS</b>	RULLI PER TRANSPALLET CON RIVESTIMENTO IN POLIURETANO POLYURETHANE ROLLERS FOR TRANSPALLETS RODILLOS DE POLIURETANO PARA TRANSPALETAS GALETS TRANSPALETES EN POLYURÉTHANE	page 13
<b>€</b>	LISTINO PRICE LIST LISTA DE PRECIOS TARIF	page 14

**RUOTE PER MOBILIO / FURNITURE WHEELS**  
**RUEDAS PARA MOBILIARIO / ROULETTES D'AMEUBLEMENT**

<b>RGTFO</b>	RUOTE IN GOMMA GRIGIA CON NUCLEO IN POLIPROPILENE GREY RUBBER WHEELS WITH POLYPROPYLENE CENTRE RUEDAS CON BANDA DE CAUCHO GRIS Y NUCLEO DE POLIPROPILENO ROUES EN CAOUTCHOUC GRIS AVEC CENTRE EN POLYPROPYLENE	page 17
<b>RGMFO</b>	RUOTE IN GOMMA GRIGIA CON NUCLEO IN LAMIERA GREY RUBBER WHEELS WITH STEEL CENTRE RUEDAS CON BANDAJE DE CAUCHO GRIS Y NUCLEO DE ACERO ROULETTES EN CAOUTCHOUC GRIS ET JANTES EN ACIER	page 18

**TPRP** RUOTE IN GOMMA TERMOPLASTICA (TPR) GRIGIA CON NUCLEO IN POLIPROPILENE  
GREY THERMOPLASTIC (TPR) RUBBER WHEELS WITH POLYPROPYLENE CENTRE  
RUEDAS CON BANDA DE CAUCHO TERMOPLASTICO (TPR) Y NUCLEO DE POLIPROPILENO  
ROULETTES EN CAOUTCHOUC THERMOPLASTIQUE (TPR) ET CORPS EN POLYPROPYLENE page 19

**TNYFO** RUOTE GEMELLATE IN POLIAMMIDE  
TWIN POLIAMMIDE WHEELS  
RUEDAS PAREADAS DE POLIAMIDA  
ROULETTES EN POLYAMIDE A DOUBLE GALETS page 20

**PNFO** RUOTE IN MATERIALE PLASTICO NERO  
BLACK PLASTIC WHEELS  
RUEDAS DE PLASTICA NEGRA  
ROULETTES EN PLASTIQUE NOIR page 21

**RUOTE PER LA COLLETTIVITÀ / COMMUNITIES CASTORS  
RUEDAS PARA LA COMUNIDAD / ROULETTES DE COLLECTIVITÉ**

**TMEDP** RUOTE GEMELLATE IN POLIAMMIDE E TPU  
POLIAMMIDE AND TPU TWIN WHEELS  
RUEDAS PAREADAS DE POLIAMIDA Y TPU  
ROULETTES EN POLYAMIDE ET TPU A DOUBLE GALETS page 22

**TMEDB** RUOTE GEMELLATE IN POLIPROPILENE E TPU  
POLYPROPYLENE AND TPU TWIN WHEELS  
RUEDAS PAREADAS DE POLIPROPILENO Y TPU  
ROULETTES EN POLYPROPYLENE ET TPU A DOUBLE GALETS page 23

**MEDP** RUOTE IN GOMMA TERMOPLASTICA (TPR) GRIGIA CON NUCLEO IN POLIPROPILENE  
GREY THERMOPLASTIC (TPR) RUBBER WHEELS WITH POLYPROPYLENE CENTRE  
RUEDAS CON BANDA DE CAUCHO TERMOPLASTICO (TPR) Y NUCLEO DE POLIPROPILENO  
ROULETTES EN CAOUTCHOUC THERMOPLASTIQUE (TPR) ET CORPS EN POLYPROPYLENE page 24

**MEDB** RUOTE IN GOMMA TERMOPLASTICA (TPR) GRIGIA CON NUCLEO IN POLIPROPILENE  
GREY THERMOPLASTIC (TPR) RUBBER WHEELS WITH POLYPROPYLENE CENTRE  
RUEDAS CON BANDA DE CAUCHO TERMOPLASTICO (TPR) Y NUCLEO DE POLIPROPILENO  
ROULETTES EN CAOUTCHOUC THERMOPLASTIQUE GRIS (TPR) ET CORPS EN POLYPROPYLENE page 25

**€** LISTINO  
PRICE LIST  
LISTA DE PRECIOS  
TARIF page 26

**RUOTE PNEUMATICHE / PNEUMATIC WHEELS  
AROS NEUMÁTICOS / ROUES PNEUMATIQUES**

**PR** RUOTE PNEUMATICHE PER CARRELLI E CARRIOLE  
PNEUMATIC WHEELS FOR HAND TROLLEYS AND WHEELBARROWS  
AROS NEUMÁTICOS PARA CARROS DE CARGA Y CARRETILLAS  
ROUES PNEUMATIQUES POUR CHARIOTS ET BROUETTES page 28

**PR GR** RUOTE PNEUMATICHE GARDEN  
GARDEN PNEUMATIC WHEELS  
AROS NEUMÁTICOS GARDEN  
ROUES PNEUMATIQUES GARDEN page 30

**SET** SET DI RICAMBIO  
SPARE PARTS KIT  
ACCESORIOS PARA AROS NEUMÁTICOS  
RECHANGE POUR ROUES PNEUMATIQUES page 31

**RUOTE ANTIFORATURA / FOAM PU WHEELS  
AROS IMPINCHABLES / ROUES INCREVABLES**

**FFP** RUOTE ANTIFORATURA PER CARRELLI E CARRIOLE  
PUNCTURE-PROOF WHEELS FOR HAND TROLLEYS AND WHEELBARROWS  
AROS IMPINCHABLES PARA CARROS DE CARGA Y CARRETILLAS  
ROUES INCREVABLES POUR CHARIOTS ET BROUETTES page 32

**€** LISTINO  
PRICE LIST  
LISTA DE PRECIOS  
TARIF page 34

# RUOTE PNEUMATICHE PER CARRELLI E CARRIOLE

## PNEUMATIC WHEELS FOR HAND TROLLEYS AND WHEELBARROWS

### AROS NEUMÁTICOS PARA CARROS DE CARGA Y CARRETILLAS

### ROUES PNEUMATIQUES POUR CHARIOTS ET BROUETTES

Ruote pneumatiche costituite da cerchio, camera d'aria e copertura.

Resistenti agli urti e alla corrosione, assorbono le vibrazioni.

Impiego: carrelli a movimentazione manuale e carriole.

Ruote 10"X3.00-4 disponibili anche nella versione con supporto fisso, con piastra girevole e girevole con freno.

Pneumatic wheels composed by rim, tube and tyre.

Shock and corrosion resistant, absorbs vibrations.

Applications: hand trolleys and wheelbarrows.

The wheels with diameter 10"x3.00-4 are available with fixed plate, swivel and swivel with brake castors.

Aros neumáticos con núcleo, tubo interior y cubierta.

Resistentes a golpes y corrosión, absorben vibraciones.

Aplicaciones: carros de carga y carretillas.

Las ruedas de diametro 10"X3.00-4 estan disponibles con soporte con placa fija , placa giratoria y con freno.

Roues pneumatiques avec jante, pneues et chambre à air.

Bonne résistance aux chocs, aux vibrations et à la corrosion.



























Application: chariots de manutention manuelle et brouettes.

Le roulettes de diamètre 10"X3.00-4 sont disponibles avec montures avec fixation par platine fixe, platine pivotante et pivotante à frein.

NÚCLEO DE PLÁSTICO  
JANTE EN PLASTIQUE

NUCLEO IN PLASTICA  
PPRIM CENTRE

NUCLEO IN LAMIERA VERNICIATA  
METAL PAINTED CENTRE

Misura Size tyre					Foro Hole	Tele P.R.	Battistrada Tread		Codice Code
	[mm]	[mm]	[mm]	[mm]		[n.]		[kg]	cod.
200x50	200	50	20	60		4	A	120	PR1409
8"x2.50-4	220	65	20	75		2	B	120	PR1403
8"x2.50-4	220	65	25	75		4	B	140	PR1403-25
8"x2.50-4	220	65	20	75		2	B	120	PR1403RULL
10"x3.00-4	260	85	20	75		4	C	140	PR1805-2
10"x3.00-4	260	85	25	75		4	C	140	PR1806-2
10"x3.00-4	260	85	20	75		4	C	140	PR1805-4
10"x3.00-4	260	85	25	75		4	C	140	PR1806-4
10"x4.10/3.50-4	260	85	20	75		4	D	140	PR1800
10"x4.10/3.50-4	260	85	20	75		4	D	140	PR1800-1
11"x4.00-4	300	100	20	75		4	C	140	PR1808-2
11"x4.00-4	300	100	20	75		4	C	140	PR1808-4
10"x3.00-4	260	85	20	75		4	C	140	PR1805-2M
10"x3.00-4	260	85	20	75		4	C	140	PR1805-5
10"x3.00-4	260	85	20	75		4	C	140	PR1805-8
10"x3.00-4	260	85	15	95		4	C	140	PR1805-95-15
10"x4.10/3.50-4	260	85	20	75		4	D	140	PR1800-2
10"x4.10/3.50-4	260	85	17	50 Offset		4	E/D	140	PR1804-17 /D
10"x4.10/3.50-4	260	85	20	50 Offset		4	E	140	PR1804-20
11"x4.00-4	300	100	20	75		4	C	140	PR1808-5
11"x4.00-4	300	100	20	75		4	C	140	PR1808-8

### Battistrada: Tread:



PR



200-400  
mm



120-170  
kg



















-5 / +50  
°C









-



Misura Size tyre	 [mm]	 [mm]	 [mm]	 [mm]	Foro Hole	Tele P.R. [n.]	Battistrada Tread	 [kg]	Codice Code
13"x4.00-6	330	100	20 25	75		2	A	150	PR2403PB PR2403PB-25
14"x3.50-8	360	85	20 25	75		2	A	150	PR2601PB PR2601PB-25
14"x3.50-8	360	85	20 25	75		2	A	150	PR2601RB PR2601RB-25
14"x3.50-8	360	85	20 25	75		2	BK	130	PR2601PB-BK PR2601PB-25BK
14"x3.50-8	360	85	20 25	75		2	BK	130	PR2601RB-BK PR2601RB-25BK
14"x3.50-8	360	85	20 25	75		4	DC	170	PR2601PB-DC PR2601PB-25DC
14"x3.50-8	360	85	20 25	75		4	DC	170	PR2601RB-DC PR2601RB-25DC
16"x4.00-8	400	100	20 25	75		2	A	150	PR3004PB PR3004PB-25
16"x4.00-8	400	100	20 25	75		2	A	150	PR3004RB PR3004RB-25
16"x4.00-8	400	100	20 25	75		4	DC	150	PR3004PB-DC PR3004PB-25DC
16"x4.00-8	400	100	20 25	75		4	DC	150	PR3004RB-DC PR3004RB-25DC



Misura Size tyre	 [mm]	 [mm]	 [mm]	 [mm]	Foro Hole	Tele P.R. [n.]	Battistrada Tread	 [kg]	Codice Code
14"x3.50-8	360	85	12	150	M12X200	2	A	150	PR2603-1
14"x3.50-8	360	85	12	150	M12X200 ball bearing	2	A	150	PR2603-3
14"x3.50-8	360	85	12	150	M12X200	2	F	150	PR2603-2
14"x3.50-8	360	85	12	115	M12X170 CORTO	4	DC	170	PR2603-4DC
14"x3.50-8	360	85	12	155	M12X210 LUNGO	4	DC	170	PR2603-5DC
14"x3.50-8	360	85	12	150	M12X200 ball bearing	4	DC	170	PR2603-3DC
14"x3.50-8	360	85	20	240	20X240 FISSO	2	BK	130	PR2603S-20X240
16"x4.00-8	400	100	12	150	M12X200	2	A	150	PR3003-1
16"x4.00-8	400	100	12	150	M12X200 ball bearing	2	A	150	PR3003-3
16"x4.00-8	400	100	12	115	M12X170 CORTO	4	DC	170	PR3003-4DC
16"x4.00-8	400	100	12	155	M12X210 LUNGO	4	DC	170	PR3003-5DC
16"x4.00-8	400	100	12	150	M12X200 ball bearing	4	DC	170	PR3003-3DC
16"x4.00-8	400	100	12	150	M12X200	2	B	150	PR3002-1
16"x4.00-8	400	100	12	150	2flange d.20x380	2	B	150	PR3002-2
4.80-4.00-8	400	100	20	100		2	H	150	PR3003-8



**Battistrada:  
Tread:**













# RUOTE PNEUMATICHE GARDEN GARDEN PNEUMATIC WHEELS AROS NEUMÁTICOS GARDEN ROUES PNEUMATIQUES GARDEN

Ruote pneumatiche costituite da cerchio, camera d'aria e copertura.  
Resistenti agli urti e alla corrosione, assorbono le vibrazioni.  
Impiego: attrezzature per il garden e per l'agricoltura.

Pneumatic wheels composed by rim, tube and tyre.  
Shock and corrosion resistant, absorbs vibrations.  
Applications: garden and agricultural equipments.

Aros neumáticos con núcleo, tubo interior y cubierta.  
Resistentes a golpes y corrosión, absorben vibraciones.  
Aplicaciones: equipos de jardín y agrícolas.

Roues pneumatique avec jante, pnues et chambre à air.  
Bonne résistance aux chocs, aux vibrations et à la corrosion.  
Applications: équipements de jardin et agricoles.

Misura Size tyre	 [mm]	 [mm]	 [mm]	 [mm]	Nucleo Centre	Foro Hole	Tele P.R.	Battistrada Tread	 [kg]	Codice Code cod.
13"x5.00-6	330	110	25	80	Lamiera verniciata Painted metal		4	GR	150	PR2408
13"x5.00-6	330	110	25	80	Lamiera verniciata Painted metal		4	GR	150	PR2408-2B
15"x6.00-6	380	135	25	75	Lamiera verniciata Painted metal		4	GR	170	PR3009
15"x6.00-6	380	135	25	75	Lamiera verniciata Painted metal		4	GR	170	PR3009-2B
16"x4.00-8	400	100	12	100	Lamiera verniciata Painted metal		4	TR	250	PR3002-TR2
16"x6.50-8	405	125	25	80	Lamiera verniciata Painted metal		4	GR	250	PR3008
16"x6.50-8	405	125	25	80	Lamiera verniciata Painted metal		4	GR	250	PR3008-2B







GR



TR

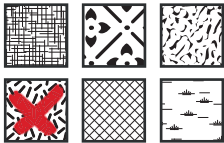

**Battistrada:  
Tread:**

<b>PR GR</b>						
		330-405 mm	150-250 kg	-5 / +50 °C	-	

# SET DI RICAMBIO SPARE PARTS KIT ACCESORIOS PARA AROS NEUMÁTICOS RECHANGE POUR ROUES PNEUMATIQUES

Set di ricambio per ruote pneumatiche copertura. Spare parts kit for pneumatic wheels composed by tube and tyre. Accesorios para aros neumáticos con cubiertas y tubo interior. Pièces de rechange pour roues pneumatiques formés par chambre à air et pneus.

Misura Size tyre	Battistrada Tread	Tele P.R. [n.]	Valvola Valve	Codice Codigo cod.
200x50	A	4PR		TYRE200504PR
200x50			TR87	TUBE20050
8"x2.50 - 4	B	4PR		TYRE25044PR
8"x2.50 - 4			TR87	TUBE2504000
10"x3.00 - 4	C	4PR		TYRE30044PR
10"x3.00 - 4	A	4PR		TYRE30044PR-A
10"x3.00 - 4	TR	4PR		TYRE30044PR-TR2
10"x3.00 - 4			TR87	TUBE3004000
10"x4.10/3.50 - 4	GR	4PR		TYRE41035044PR GR
10"x4.10/3.50 - 4	D	4PR		TYRE41035044PR D
10"x4.10/3.50 - 4	E	4PR		TYRE41035044PR E
11"x4.00 - 4	GR	4PR		TYRE1140044PRGR
11"x4.00 - 4	C	4PR		TYRE1140044PRXI-C
10"x4.10/3.50 - 4 11"x4.00-4			TR13 TR87	TUBE4103504TR13 TUBE4103504TR87
13"x5.00 - 6	GR	4PR		TYRE1350064PR
13"x5.00 - 6			TR13	TUBE500600
14"x3.50 - 6	TD	4PR		TYRE350644PRTD
14"x3.50 - 6			TR13	TUBE3506000
14"x3.50 - 8	A	2PR		TYRE35082PR
14"x3.50 - 8	DC	4PR		TYRE35084PRDC
14"x3.50 - 8	BK	4PR		TYRE35084PRBK
14"x3.50 - 8			TR13	TUBE3508000TR13
15"x6.00 - 6			TR13	TUBE6006TR13
16"x4.00 - 6			TR13 TR87	TUBE4006TR13 TUBE4006TR87
16"x4.00 - 8	A	4PR		TYRE40084PR
16"x4.00 - 8	DC	4PR		TYRE40084PRDC
16"x4.00 - 8	TR	4PR		TYRE40084PRTR2
16"x4.00 - 8			TR13 TR87	TUBE4008000TR13 TUBE4008000TR87
16"x4.00 - 10	TR	4PR		TYRE400104PR-TR2

## Battistrada: Tread:

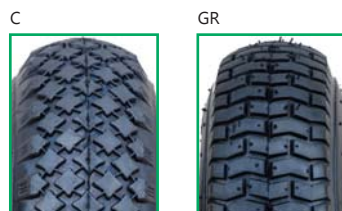
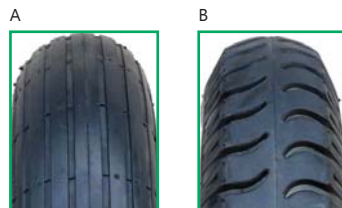

**SET**



200-405  
mm



-



-5 / +50  
°C



-



# RUOTE ANTIFORATURA PER CARRELLI E CARRIOLE PUNCTURE-PROOF WHEELS FOR HAND TROLLEYS AND WHEELBARROWS AROS IMPINCHABLES PARA CARROS DE CARGA Y CARRETILLAS ROUES INCREVABLES POUR CHARIOTS ET BROUETTES

Ruote con nucleo in plastica o in lamiera verniciata e anello antiforatura in poliuretano.

Resistenti agli urti e alla corrosione, assorbono le vibrazioni, impermeforabili.

Impiego: carrelli a movimentazione manuale e carriole.

Ruote 10"x3.00-4 disponibili anche nella versione con supporto fisso, con piastra girevole e girevole con freno.

Wheels with plastic or painted metal rim and puncture-proof ring made of polyurethane foam.

Shock and corrosion resistant, absorbs vibrations, puncture proof.

Applications: hand trolleys and wheelbarrows.

The wheels with diameter 10"x3.00-4 are available with fixed plate, swivel and swivel with brake castors.

Aros impinchables con núcleo de plástico o metal pintado, con anillo de espuma de poliuretano.

Resistentes a golpes y corrosión, absorben vibraciones, impinchables.

Aplicaciones: carros de carga y carretillas.

Las ruedas de diametro 10"x3.00-4 estan disponibles con soporte con placa fija, placa giratoria y con freno.

Roues avec jante en matière plastique ou en tôle d'acier et à bandage increvables en éponge de polyuréthane.

















Bonne résistance aux chocs, aux vibrations et à la corrosion, increvables.

Pour les chariots de manutention manuelle, et brouettes.

Le roulettes de diamètre 10"x3.00-4 sont disponibles avec montures avec fixation par platine fixe, platine pivotante et pivotante à frein.

NUCLEO IN PLASTICA  
PPRIM CENTRE















NÚCLEO DE PLÁSTICO  
JANTE EN PLASTIQUE

Misura Size tyre	 [mm]	 [mm]	 [mm]	 [mm]	Foro Hole	Battistrada Tread	 [kg]	Colore Color	Codice Codigo cod.
200x50	200	50	20	60			80	black blue	FFP1409-60
200x50	200	50	20	75			80	black	FFP1409
10"x3.00-4	263	73	20	75			80	black yellow blue	FFP1105 FFP1105Y FFP1105AZ
10"x3.00-4	263	73	20/25	75			80	black yellow blue green	FFP1105R FFP1105RY FFP1105RAZ FFP1105RVE
10"x3.00-4	260	85	25	75			80	black	FFP1105R-25
10"x4.10/3.50-4	260	85	20	75			80	black	FFP1115R (ex 1502)



NUCLEO IN LAMIERA VERNICIATA  
METAL PAINTED CENTRE





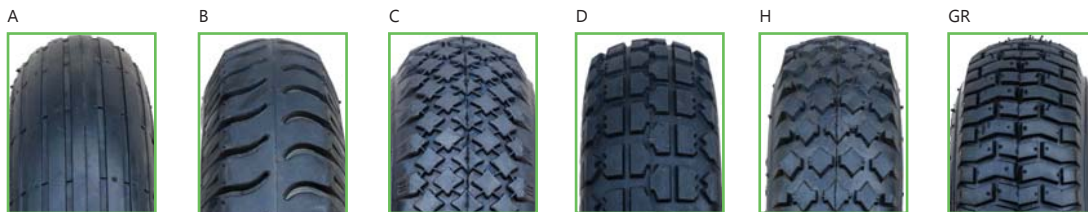

NÚCLEO DE METAL PINTADO  
JANTE EN MÉTAL PEINT

Misura Size tyre	 [mm]	 [mm]	 [mm]	 [mm]	Foro Hole	Battistrada Tread	 [kg]	Colore Color	Codice Codigo cod.
8"x2.50-4	220	65	20	75			80	black	FFP1501
10"x3.00-4	263	73	20	75			80	black yellow blue	FFP1107 FFP1107Y FFP1107AZ
10"x4.10/3.50-4	260	85	20	75			80	black	FFP1503
10"x4.10/3.50-4	260	85	20	75			80	black	FFP1503R
10"x4.10/3.50-4	260	85	17	50 Offset			80	black	FFP1804-17



Battistrada:  
Tread:











<b>FFP</b>		 200-405 mm	 80-140 kg	 -5 / +50 °C	 -	
------------	---	--	---	---	--	---



NUCLEO IN PLASTICA  
PPRIM CENTRE





NÚCLEO DE PLÁSTICO  
JANTE EN PLASTIQUE

Misura Size tyre	 [mm]	 [mm]	 [mm]	 [mm]	Foro Hole	Battistrada Tread	 [kg]	Codice Code cod.
14"x3.50-8	360	85	20	75		A	140	FFP2601PB
14"x3.50-8	360	85	20	75		A	140	FFP2601RB
16"x4.00-8	400	85	20	75		A	140	FFP1302PB
16"x4.00-8	400	85	20	75		A	140	FFP1302RB black / yellow



NUCLEO IN LAMIERA VERNICIATA  
METAL PAINTED CENTRE









NÚCLEO DE METAL PINTADO  
JANTE EN MÉTAL PEINT

Misura Size tyre	 [mm]	 [mm]	 [mm]	 [mm]	Foro Hole	Battistrada Tread	 [kg]	Codice Code cod.
14"x3.50-8	360	85	12	150	M12X200	A	140	FSR2603-1
14"x3.50-8	360	85	12	150	M12X200	A	140	FFP2603-1 black / yellow
14"x3.50-8	360	85	12	115	M12X170 ball bearing	A	140	FFP2603-4
14"x3.50-8	360	85	12	150	M12X200 ball bearing	A	140	FFP2603-3
14"x3.50-8	360	85	20	240	20x240 FISSO	A	140	FFP2603S-20X240
16"x4.00-8	400	100	12	150	M12X200	A	140	FFP3003-2



NUCLEO IN LAMIERA VERNICIATA  
METAL PAINTED CENTRE

NÚCLEO DE METAL PINTADO  
JANTE EN MÉTAL PEINT

Misura Size tyre	 [mm]	 [mm]	 [mm]	 [mm]	Foro Hole	Battistrada Tread	 [kg]	Codice Code cod.
13"x5.00-6	330	110	25	80		GR	130	FFP1283PB
13"x5.00-6	330	110	25	80		GR	130	FFP1283-2B
16"x6.50-8	405	125	25	80		GR	130	FFP1310PB
16"x6.50-8	405	125	25	80		GR	130	FFP1310-2B

