

CATALOGO LISTINO 2021



€ Senza IVA
61/2021



IC
ONIC
PRO
DUCT

ICONIC PRODUCT



Rete vendita

**Pagina
409**



**Carrelli portautensili
Pagina 199**



**Banchi da lavoro
Pagina 197**



**Armadi
Pagina 196-279**



**Arredamento tecnico
Pagina 200**



**Assortimenti
Pagina 174**

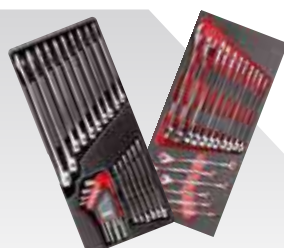

**Moduli per carrelli
Pagina 224**



**Borse e valigie
Pagina 37**



**Cassette portautensili
Pagina 277**



**Chiavi di manovra
Pagina 103-123**



**Chiavi a bussola
Pagina 82**



**Bussole macchina
Pagina 83**



**Assortimenti di bussole
Pagina 257**



**Serraggio controllato
Pagina 290**



**Giraviti
Pagina 140**



**Chiavi maschio
Pagina 114**



**Inserti
Pagina 279**



**Pinze e trochesi
Pagina 65**



**Martelli
Pagina 153**

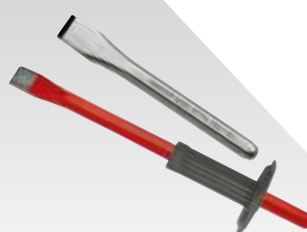

**Scalpellini
Pagina 151**



**Seghetti e cesoie
Pagina 77**



**Prodotti eliminati
e sostituzioni**

**Pagina
401**

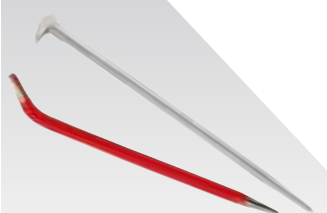

Leve

Pagina 160



Rivettatrici

Pagina 326

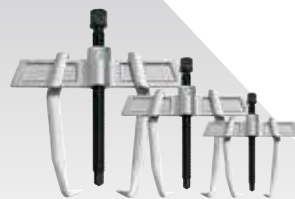

Estrattori

Pagina 166



Misura e tracciatura

Pagina 318



Idraulica

Pagina 135



Isolati 1000 V

Pagina 55



Forbici per elettricisti

Pagina 79



Elettrotecnica

Pagina 70



Illuminazione

Pagina 298



Autoriparazione

Pagina 108



Messa in fase

Pagina 327



Utensili pneumatici

Pagina 302



Matrix

Pagina 334



RMD

Pagina 356



Griffe

Pagina 390



Antiscintilla

Pagina 396



Scarpe

Pagina 333



Libero servizio

Pagina 364



Linea espositiva

Pagina 371



Linea espositori

Pagina 376

Utensili Antiscintilla

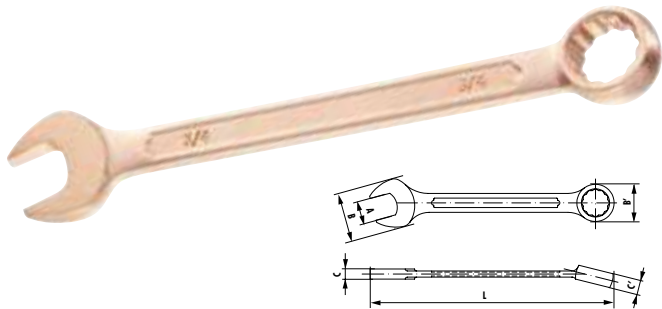

Chiavi combinate - mm Metric combination wrenches

Cod.	A mm	B mm	B' mm	C mm	C' mm	L mm	♠ gr	€
440.6SR	6	14	11,60	4,40	6	105	22	59,33
440.7SR	7	17,5	14,50	5	7	120	22	59,33
440.8SR	8	17,5	14,50	5	7	120	37	59,33
440.9SR	9	22	18	5,40	8	135	37	61,30
440.10SR	10	22	18	5,40	8	135	55	65,26
440.11SR	11	26,5	21	6	9	150	55	67,23
440.12SR	12	26,5	21	6	9	150	75	71,19
440.13SR	13	30	23	6,60	10	175	75	75,14
440.14SR	14	30	23	6,60	10	175	122	74,03
440.15SR	15	35	27	7,60	11	175	122	83,06
440.16SR	16	35	27	7,60	11	195	155	96,89
440.17SR	17	35	27	7,60	11	195	155	110,75
440.18SR	18	39	31	8	12	215	210	112,72
440.19SR	19	39	31	8	12	215	210	114,71
440.20SR	20	45	34	9,50	13,50	230	225	118,64
440.21SR	21	45	34	9,50	13,50	230	225	122,60
440.22SR	22	46	36	9,40	14	245	250	132,49
440.23SR	23	46	38	9,40	14	245	250	136,45
440.24SR	24	49	38	10	15,20	265	260	146,33
440.25SR	25	49	38	9,40	15,20	265	260	154,25
440.27SR	27	56	42	11,40	17	290	420	162,16
440.30SR	30	61	49	13	20	320	560	187,87
440.32SR	32	65	52	14	21	340	670	237,31
440.34SR	34	72	52	15	21	360	850	241,35
440.35SR	35	72	55	15	21	360	890	247,18
440.36SR	36	72	55	15	21	360	890	266,96
440.41SR	41	82	64	15	21	430	1440	338,15
440.46SR	46	90	70	16	22	480	1890	393,52
440.50SR	50	98	77	17	23	520	2220	435,05
440.55SR	55	108	83	18	23	560	2780	474,59
440.60SR	60	115	89	20	25	595	3230	514,14
440.65SR	65	125	95	21	27	595	3680	652,57
440.70SR	70	142	112	24	29	630	4770	751,45

Chiavi combinate - pollici Inch combination wrenches

Cod.	A"	B mm	B' mm	C mm	C' mm	L mm	♠ gr	€
440.1PSR	1"	56	42	11,40	17	290	260	154,25
440.1P1/16SR	1-1/16"	56	42	11,40	17	290	420	166,10
440.1P1/8SR	1-1/8"	61	49	13	20	320	560	185,89
440.1P3/16SR	1-3/16"	61	49	13	20	320	560	212,01
440.1P1/4SR	1-1/4"	65	52	14	21	340	670	217,53
440.1P5/16SR	1-5/16"	65	52	14	21	340	850	221,47
440.1P3/8SR	1-3/8"	72	55	15	21	360	890	276,85

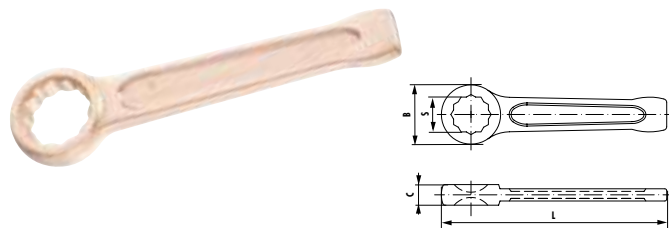

Chiavi poligonali a percussione - mm Metric slogging ring wrenches

Cod.	S mm	B mm	C mm	L mm	♠ gr	€
50.19SR	19	32	12	145	200	110,75
50.24SR	24	42	14	165	235	114,71
50.27SR	27	46	16	175	350	116,67
50.30SR	30	53	16	185	475	124,57
50.34SR	34	58	19	205	580	145,50
50.36SR	36	58	19	205	580	158,19
50.41SR	41	64	20	225	755	231,37
50.46SR	46	73	22	235	990	266,96
50.50SR	50	78	23	250	1145	301,57
50.55SR	55	86	23,50	265	1440	306,51
50.60SR	60	92	25,50	274	1620	355,94
50.65SR	65	102	30	298	1995	415,27
50.70SR	70	108	31,50	320	2435	553,70
50.75SR	75	113	33	326	3010	573,48
50.80SR	80	124	34	350	3600	662,45
50.85SR	85	130	36	355	4330	702,01
50.90SR	90	142	39	390	5500	781,11
50.95SR	95	142	39	390	5450	810,76
50.100SR	100	155	43	420	7080	986,76
50.105SR	105	155	43	420	7000	1.819,29
50.110SR	110	168	45	450	9130	1.230,20
50.120SR	120	182	50	480	11000	1.777,75

Chiavi poligonali a percussione - pollici Inch slogging ring wrenches

Cod.	S"	B mm	C mm	L mm	♠ gr	€
50.1P1/16SR	1-1/16"	46	16	175	350	126,56
50.1P1/4SR	1-1/4"	53	16	185	470	148,31
50.1P3/8SR	1-3/8"	58	19	205	560	159,22
50.1P1/2SR	1-1/2"	64	20	225	790	213,62
50.1P5/8SR	1-5/8"	64	20	225	755	197,75
50.1P3/4SR	1-3/4"	73	22	235	1020	209,13
50.1P13/16SR	1-13/16"	73	22	235	990	233,34
50.2P3/16SR	2-3/16"	86	23,50	265	1350	324,23
50.2P3/8SR	2-3/8"	92	25,50	274	1620	375,72
50.2P5/8SR	2-5/8"	102	30	298	1900	474,59
50.2P3/4SR	2-3/4"	108	31,50	320	2270	593,25
50.3P1/16SR	3-1/16"	124	34	350	2820	692,13
50.3P15/16SR	3-15/16"	155	43	420	6730	1.063,81

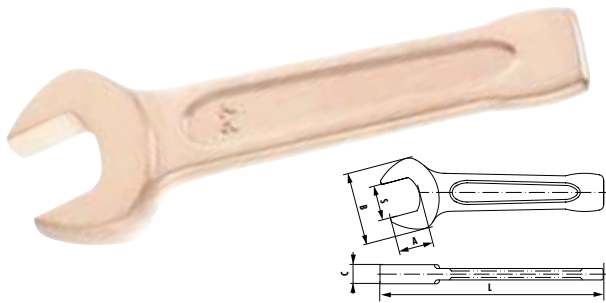

Chiavi a forchetta a percussione - mm Metric open-end slogging wrenches

Cod.	S mm	A mm	B mm	C mm	L mm	♠ gr	€
49.17SR	17	17	40,5	12	125	150	98,88
49.19SR	19	19	40,5	12	125	150	102,83
49.22SR	22	22	46	12	135	195	106,78
49.24SR	24	24	50	12	150	245	114,71
49.27SR	27	27	57	15	175	335	128,54
49.30SR	30	30	64	15,5	190	435	158,19
49.32SR	32	32	66	16	190	515	168,09
49.36SR	36	36	75	17	210	725	187,87
49.41SR	41	41	87	18,5	230	955	227,40
49.46SR	46	46	98	20	250	1225	286,73
49.50SR	50	50	108	20,5	275	1340	336,17
49.55SR	55	55	117	23	305	1665	385,62
49.60SR	60	60	128	23,5	315	2190	484,49
49.65SR	65	65	141	27,5	335	2670	533,92
49.70SR	70	70	156	28,5	370	3250	702,01
49.75SR	75	75	162	29	375	3660	721,79
49.85SR	85	85	174	32	400	5290	959,30
49.90SR	90	90	194	36	445	6640	1.176,61

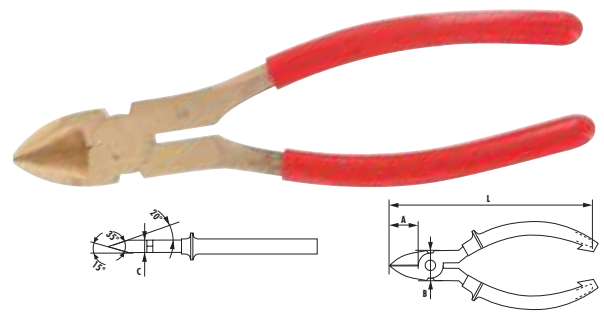

Tronchesi diagonali Diagonal cutting pliers

Cod.	A mm	B mm	L mm	♠ gr	€
192.16SR	20	24	150	205	237,31
192.20SR	30	28	195	310	196,54

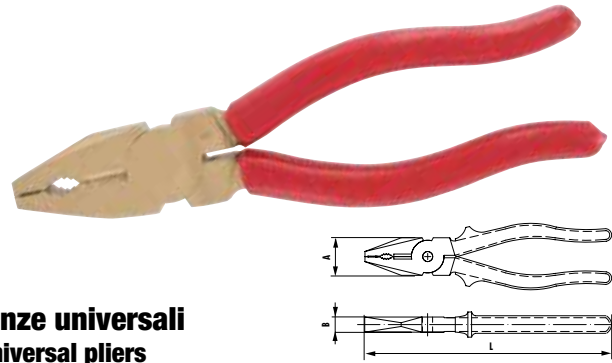

Pinze universali Universal pliers

Cod.	A mm	B mm	L mm	♠ gr	€
187.16SR	24	11	150	180	233,34
187.18SR	28	12	175	306	238,86
187.20SR	28	12	195	405	244,78



Chiavi a rullino Adjustable wrenches

Cod.	A mm	B mm	E mm	D mm	L mm	♠ gr	€
113A.6SR	18	18	10,8	6,6	150	135	134,54
113A.8SR	24	24	13,3	9	200	281	183,97
113A.10SR	30	28	15,7	10,5	250	440	243,39
113A.12SR	36	33	18,8	11,2	300	720	273,82
113A.15SR	46	42	23,4	13,7	375	1410	480,03
113A.18SR	55	51	26,7	15	450	2261	632,80

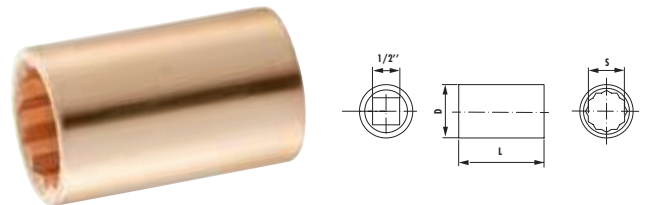

Bussole poligonali 1/2"- mm Metric 1/2" drive socket wrenches

Cod.	S mm	D max mm	L mm	♠ gr	€
S.6SR	6	24	40	75	79,10
S.7SR	7	24	40	77	81,07
S.8SR	8	24	40	77	83,06
S.9SR	9	24	40	78	85,04
S.10SR	10	24	40	78	87,01
S.11SR	11	24	40	79	88,99
S.12SR	12	24	40	79	90,97
S.13SR	13	24	40	80	92,94
S.14SR	14	24	40	80	94,91
S.15SR	15	25	40	82	96,89
S.16SR	16	25	40	85	98,88
S.17SR	17	25	40	88	106,78
S.18SR	18	26	42	90	108,77
S.19SR	19	28	42	110	110,75
S.20SR	20	29	43	120	112,72
S.21SR	21	30	43	137	118,64
S.22SR	22	31	43	143	122,60
S.23SR	23	33	43	159	126,56
S.24SR	24	34	43	186	134,48
S.25SR	25	36	43	197	138,42
S.26SR	26	37	43	207	148,31
S.27SR	27	38	46	235	154,25
S.28SR	28	39	46	245	158,19
S.29SR	29	41	46	250	168,09
S.30SR	30	42	46	285	174,02
S.32SR	32	44	46	320	177,98

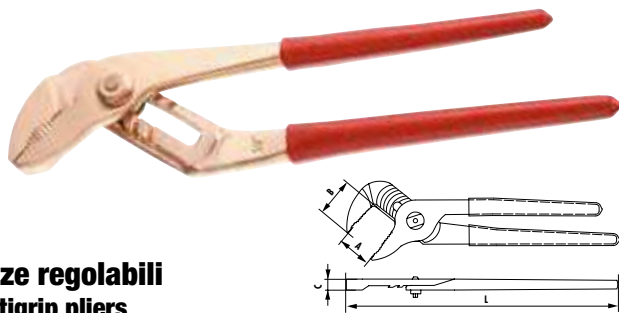

Pinze regolabili Multigrip pliers

Cod.	A mm	B mm	C mm	L mm	♠ gr	€
482.25SR	45	36	10	250	453	243,31
482.30SR	55	52	11	300	745	294,64

Bussole poligonali 1/2"- Inch 1/2" drive socket wrenches

Cod.	S "	D max mm	L mm	g gr	€
S.5/16SR	5/16"	24	40	78	79,10
S.3/8SR	3/8"	24	40	78	81,07
S.7/16SR	7/16"	24	40	79	83,06
S.1/2SR	1/2"	24	40	79	88,99
S.9/16SR	9/16"	24	40	80	92,94
S.5/8SR	5/8"	24	40	88	96,89
S.11/16SR	11/16"	26	40	93	106,78
S.3/4SR	3/4"	28	42	99	108,77
S.13/16SR	13/16"	30	43	120	112,72
S.7/8SR	7/8"	32	43	142	114,71
S.15/16SR	15/16"	34	43	148	118,64
S.1PSR	1"	36	43	159	128,54
S.1P1/16SR	1-1/16"	38	46	241	134,48
S.1P1/4SR	1-1/4"	43	46	276	209,61
S.1P7/16SR	1-7/16"	49	47	308	253,53

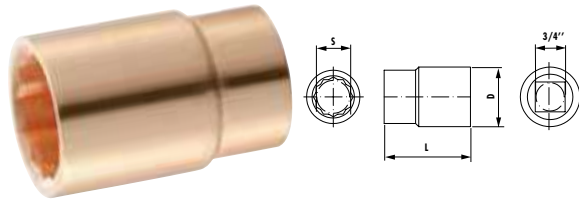

Bussole poligonali 3/4"- mm Metric 3/4" drive socket wrenches

Cod.	S mm	D max mm	L mm	g gr	€
K.17SR	17	38	50	246	132,17
K.19SR	19	38	50	246	132,76
K.21SR	21	38	55	268	146,21
K.22SR	22	38	55	268	149,72
K.23SR	23	40	55	306	153,23
K.24SR	24	40	55	307	168,09
K.26SR	26	40	55	307	174,93
K.27SR	27	40	55	312	177,98
K.28SR	28	40	55	339	188,87
K.29SR	29	40	55	350	190,08
K.30SR	30	43	60	410	187,87
K.32SR	32	45	60	465	197,75
K.34SR	34	45	60	480	209,71
K.36SR	36	45	60	510	237,31
K.38SR	38	46	60	555	240,20
K.41SR	41	48	65	660	276,85
K.46SR	46	50	65	830	316,40
K.50SR	50	50	70	945	355,94

Bussole poligonali 3/4"- Inch 3/4" drive socket wrenches

Cod.	S "	D max mm	L mm	g gr	€
K.1P1/8SR	1-1/8"	43	55	245	171,70
K.1P3/16SR	1-3/16"	44	60	400	197,59
K.1P5/16SR	1-5/16"	48	60	472	217,53
K.1P3/8SR	1-3/8"	50	60	515	237,31
K.1P7/16SR	1-7/16"	52	60	525	238,18
K.1P5/8SR	1-5/8"	58	65	702	257,08
K.1P3/4SR	1-3/4"	62	65	761	286,73
K.1P13/16SR	1-13/16"	64	65	830	296,63
K.1P7/8SR	1-7/8"	66	65	850	316,40
K.2PSR	2"	69	70	930	336,17

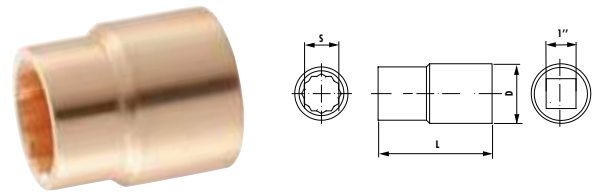

Bussole poligonali 1"- mm Metric 1" drive socket wrenches

Cod.	S mm	D max mm	L mm	g gr	€
M.30SR	30	48	60	443	316,40
M.32SR	32	48	60	481	334,20
M.34SR	34	50	60	497	395,49
M.36SR	36	52	60	505	415,27
M.41SR	41	58	65	630	444,94
M.46SR	46	64	65	785	484,49
M.50SR	50	68	70	890	514,14
M.55SR	55	74	75	1090	563,59
M.60SR	60	81	75	1220	702,01
M.65SR	65	88	80	1455	751,45
M.70SR	70	95	80	1550	830,54
M.75SR	75	103	80	2160	986,76
M.80SR	80	110	85	2405	1.048,07

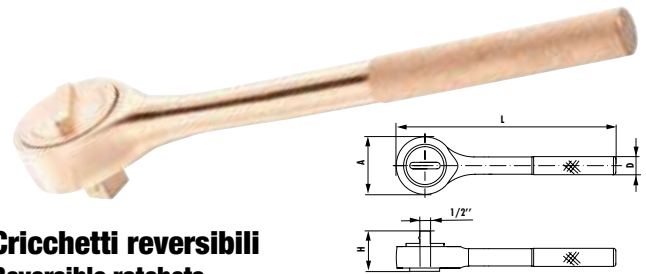

Cricchetti reversibili Reversible ratchets

Cod.	"	A mm	D mm	H mm	L mm	g gr	€
S.155SR	1/2"	48	17	43	245	690	431,92
K.149SR	3/4"	70	21	57	320	1570	694,06
M.151SR	1"	84	26	67	550	3400	1.189,33

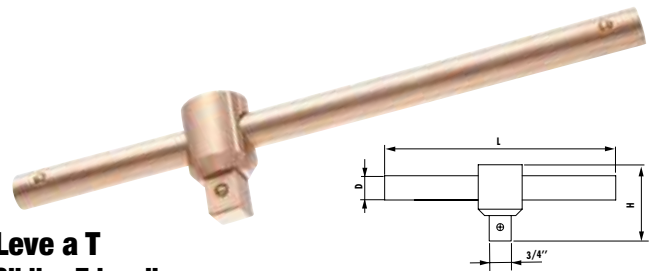

Leve a T Sliding T-handle

Cod.	"	D mm	H mm	L mm	g gr	€
S.120SR	1/2"	13	39	250	330	288,51
K.120SR	3/4"	21	56	400	1335	708,88
M.120SR	1"	21	62	400	1620	718,79

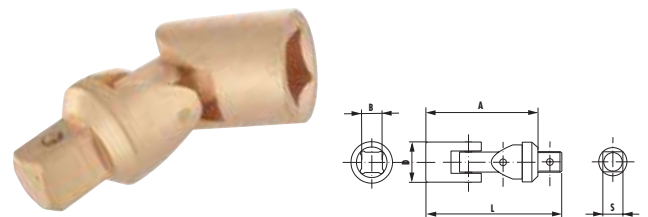

Snodi cardanici Universal joint

Cod.	"	L mm	A mm	B mm	D mm	S mm	g gr	€
S.240SR	1/2"	80	65	12,7	25	12,7	186	270,36
K.240SR	3/4"	112	90	19	38	19	500	509,41
M.240SR	1"	130	95	25,4	48	25,4	1000	830,89

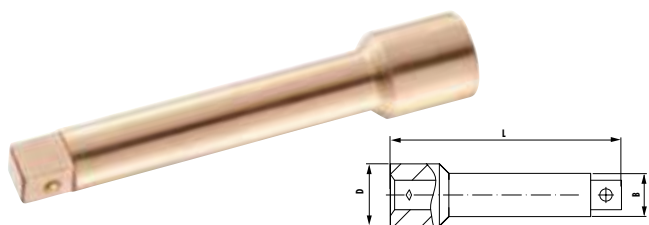

Prolunghe Extensions

Cod.	"	D mm	B mm	L mm	g	€
S.208SR	1/2"	25	18	100	245	168,18
S.210SR	1/2"	25	18	125	260	175,44
S.212SR	1/2"	25	18	200	485	184,63
S.215SR	1/2"	25	18	250	510	202,78
K.210SR	3/4"	35	25	200	960	276,96
M.210SR	1"	46	36	200	1580	478,10

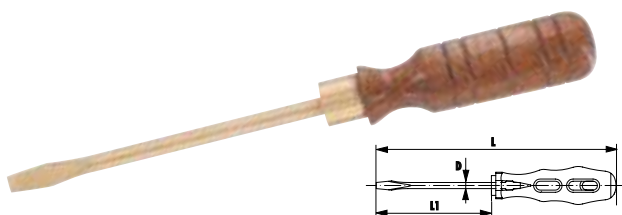

Giraviti per viti con intaglio Slotted head screwdrivers

Cod.	D mm	L1 mm	L mm	g	€
AN3X75SR	3	75	157	35	26,71
AN4X75SR	3	75	157	45	26,98
AN6X100SR	4	100	203	85	44,00
AN8X150SR	6	150	262	140	55,36
AN12X400SR	16	400	550	450	156,24

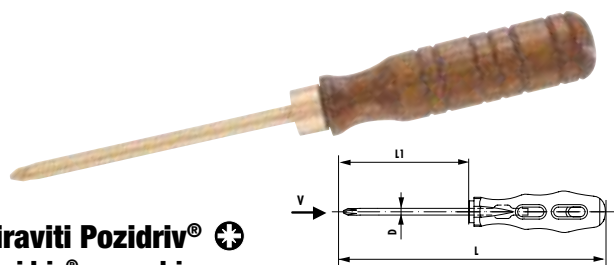

Giraviti Pozidriv® Pozidriv® screwdrivers

Cod.	Pozidriv®	D mm	L1 mm	L mm	g	€
AND0X75SR	0	3	50	132	35	21,93
AND1X75SR	1	4,50	75	157	45	25,88
AND2X100SR	2	6	100	200	85	33,33
AND3X150SR	3	8	150	262	145	45,18

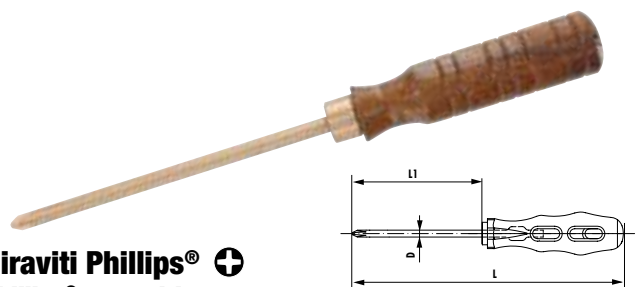

Giraviti Phillips® Phillips® screwdrivers

Cod.	Phillips®	D mm	L1 mm	L mm	g	€
ANP0X50SR	0	3	50	132	35	22,37
ANP1X100SR	1	5	100	203	75	30,70
ANP2X100SR	2	6	125	225	100	32,08
ANP3X150SR	3	8	200	312	165	54,29
ANP4X200SR	4	8	250	362	185	67,98

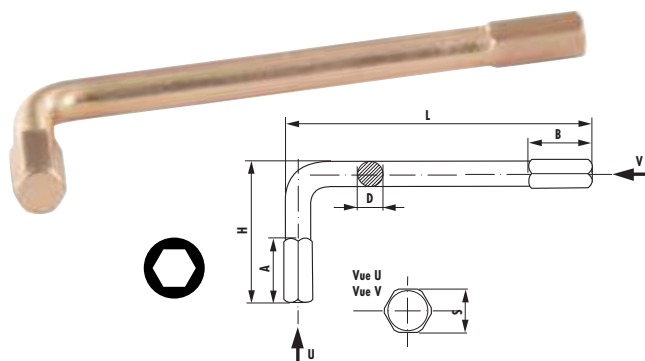

Chiavi maschio - mm Metric hex keys

Cod.	S mm	L mm	H mm	A mm	B mm	D mm	g	€
82H.2SR	2	38	13	5	5	3	6	35,59
82H.3SR	3	59	25	7	7	3,7	8	36,04
82H.7SR	7	88	43	20	20	6	34	44,10
82H.10SR	10	110	45	20	20	9	82	54,86
82H.12SR	12	130	52	20	20	11	145	65,09
82H.17SR	17	168	65	30	30	15	370	105,97
82H.19SR	19	177	72	30	30	17	490	118,87
82H.23SR	23	189	80	35	35	21	723	139,43
82H.24SR	24	192	82	35	35	22	825	160,29

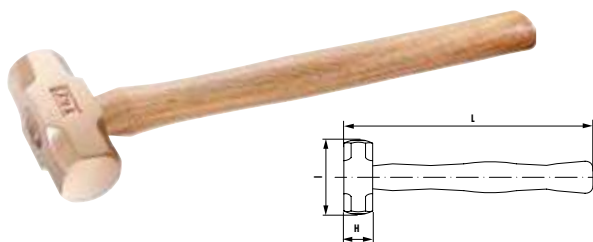

Mazzette testa tonda Round head hammers

Cod.	I mm	H mm	L mm	g	€
1261H.45SR	85	29	250	610	77,03
1261H.100SR	105	40	250	1300	168,09
1261H.250SR	149	51,50	258	3410	326,28

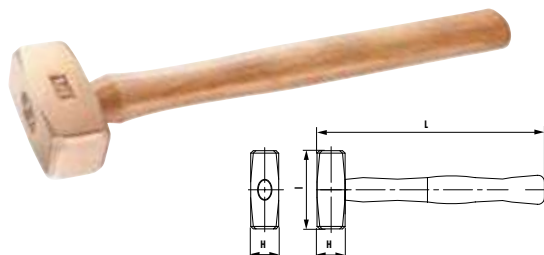

Mazzette testa quadra Square head hammers

Cod.	I mm	H mm	L mm	g	€
1262H.50SR	80	30	250	650	81,62
1262H.100SR	95	40	250	1300	168,09
1262H.150SR	118	42	250	1800	193,80
1262H.200SR	126	48	250	2300	237,31
1262H.400SR	165	58	800	4900	452,96
1262H.500SR	178	62	800	5900	567,89

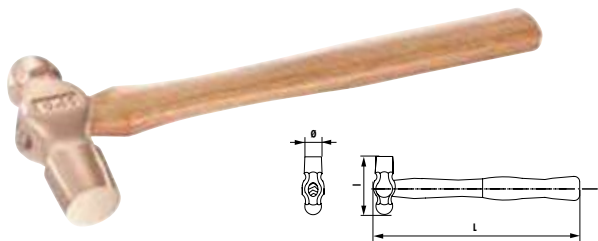

Martelli per meccanici Ball pein hammers

Cod.	L mm	Ø mm	L mm	g gr	€
202H.1/4SR	80	23	300	403	40,10
202H.1/2SR	90	26	300	502	55,98
202H.1SR	101	28	320	680	79,10
202H.1P1/2SR	126	35	366	1205	110,75
202H.2SR	137	37	397	1470	136,54

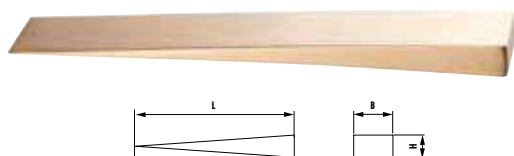

Cunei Wedges

Cod.	L mm	B mm	H mm	g gr	€
WF150.40SR	150	40	8	200	34,65
WF150.30SR	150	50	13	400	67,23
WF180.50SR	180	50	19	700	100,85
WF200.20SR	200	20	30	490	88,99
WF200.40SR	200	40	40	1315	187,87

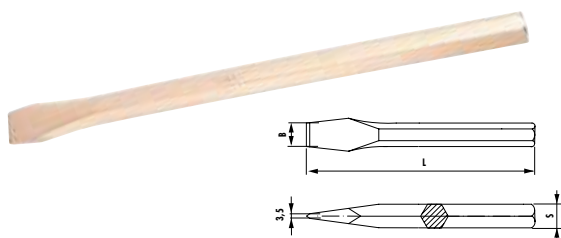

Scalpellini Chisels

Cod.	S mm	L mm	B mm	g gr	€
265.20SR	10	150	12	98	45,04
265.22SR	12	160	14	240	71,93
265.24SR	14	200	16	251	74,28
265.26SR	16	160	18	262	77,79
265.28SR	17	350	19	903	246,81
265.29SR	22	600	24	1861	509,98

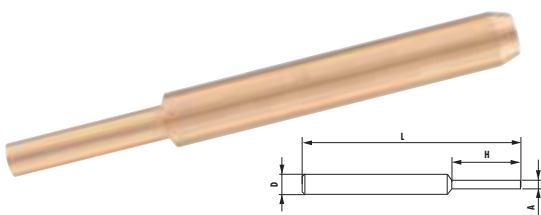

Cacciapine Drift punches

Cod.	A mm	L mm	H mm	D mm	g gr	€
249.3SR	3	110	20	9	20	56,68
249.6SR	6	115	35	12	105	69,71
249.8SR	8	120	40	14	130	74,19
249.10SR	10	145	45	16	200	74,19
249.12SR	12	160	50	18	280	78,63

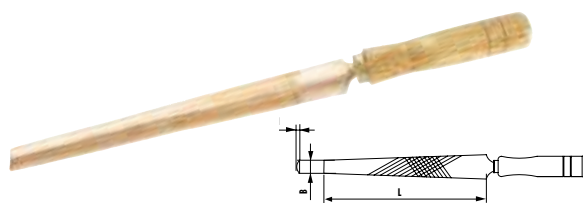

Lime mezzotonde Half-round files

Cod.	L mm	H mm	B mm	g gr	€
DRD.MD300SR	300	5	17	375	172,01

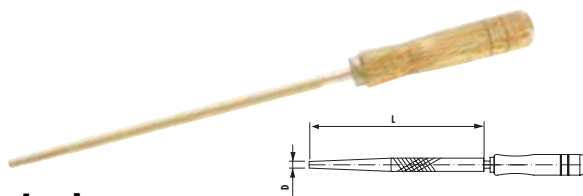

Lime tonde Round files

Cod.	L mm	D mm	g gr	€
RD.MD250SR	250	6,5	122	226,63

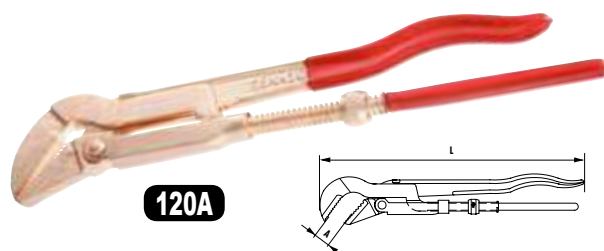

120A

Giratubi modello svedese Swedish model pipe wrenches

Cod.	A mm	D mm	L mm	g gr	€
120A.1P1/2SR	38	-	420	1427	1.773,38
120A.2PSR	50	-	530	1755	2.212,63

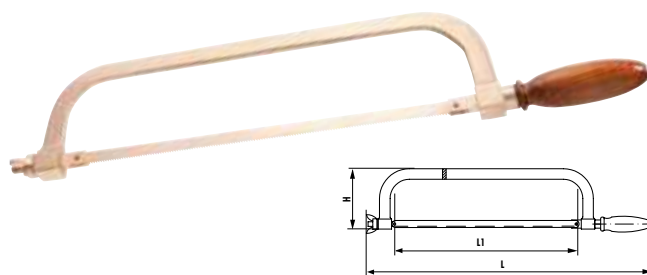

Seghetto Hacksaw

Cod.	L mm	L1 mm	H mm	g gr	€
599SR	500	300	103	645	408,47

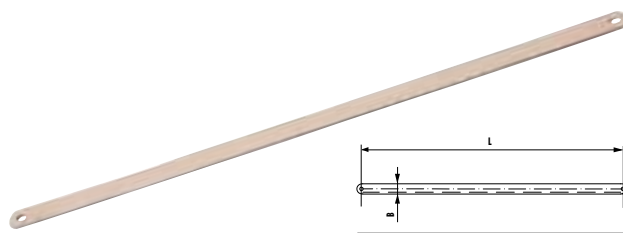

Ricambio lame Spare blades

Cod.	L mm	B mm	g gr	€
660A.10SR	300	12	32	135,64